

# Mono 2W Class D Amplifier

## General Description

The MAX9830 mono 2W Class D amplifier provides Class AB audio performance with Class D efficiency.

Active emissions limiting edge rate and overshoot control circuitry greatly reduces EMI. A filterless spread-spectrum modulation scheme eliminates the need for output filtering found in traditional Class D devices. These features reduce application component count.

The MAX9830's industry-leading 1.6mA at 5V, 1.2mA at 3.6V, quiescent current extends battery life in portable applications.

The MAX9830 is available in an 8-pin TDFN (2mm x 2mm x 0.8mm) and is specified over the extended -40°C to +85°C temperature range.

## Applications

Notebook and Netbook Computers  
Cellular Phones  
MP3 Players  
Portable Audio Players  
VoIP Phones

## Pin Configuration

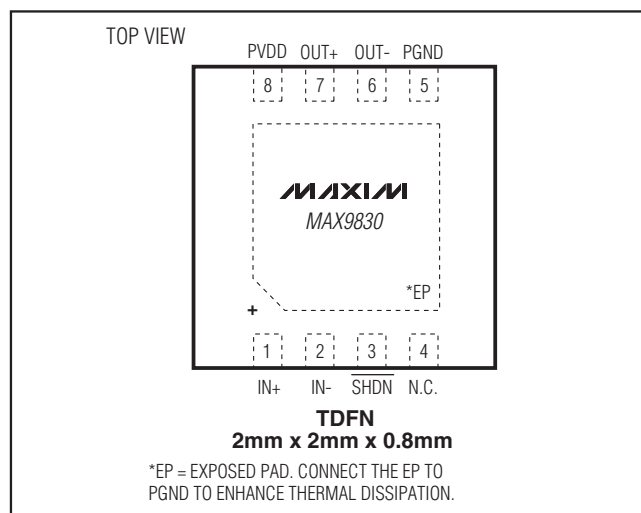

## Features

- ◆ Industry-Leading Quiescent Current: 1.6mA at 5V, 1.2mA at 3.6V
- ◆ Spread Spectrum and Active Emissions Limiting
- ◆ Passes EMI Limit Unfiltered with Up to 24in (61cm) of Speaker Cable
- ◆ Click-and-Pop Suppression
- ◆ Thermal and Overcurrent Protection
- ◆ Low 0.5µA Current Shutdown Mode
- ◆ Space-Saving, 2mm x 2mm x 0.8mm, 8-Pin TDFN Package

## Ordering Information

PART	TEMP RANGE	PIN-PACKAGE
MAX9830AETA+	-40°C to +85°C	8 TDFN-EP*

+Denotes a lead(Pb)-free/RoHS-compliant package.

\*EP = Exposed pad.

## Typical Operating Circuit

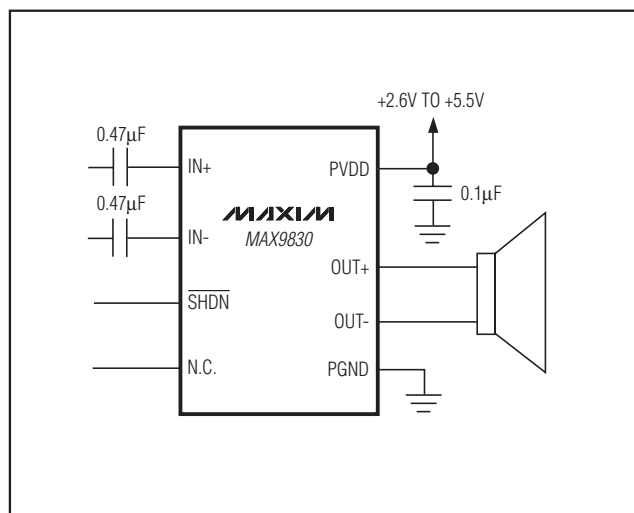

# Mono 2W Class D Amplifier

## ABSOLUTE MAXIMUM RATINGS

Voltage	PVDD, IN+, IN-, $\overline{\text{SHDN}}$ , to PGND .....-0.3V to +6V	Continuous Power Dissipation for a Multilayer Board ( $T_A = +70^\circ\text{C}$ )
	OUT+, OUT- to PGND.....-0.3V to $V_{\text{PVDD}} + 0.3\text{V}$	8-Pin TDFN-EP (derate 11.9mW/ $^\circ\text{C}$ ) .....953.5mW
Current	Continuous Current Into/Out of PVDD, PGND, OUT+, OUT- ..... $\pm 600\text{mA}$	Junction Temperature .....+150 $^\circ\text{C}$
	Continuous Input Current (all other pins) ..... $\pm 20\text{mA}$	Operating Temperature Range .....-40 $^\circ\text{C}$ to +85 $^\circ\text{C}$
Duration of Short Circuit Between	OUT+, OUT-, and PVDD, PGND .....Continuous	Storage Temperature Range .....-65 $^\circ\text{C}$ to +150 $^\circ\text{C}$
		Lead Temperature (soldering, 10s) .....+300 $^\circ\text{C}$
		Soldering Temperature (reflow) .....+260 $^\circ\text{C}$
		Rate of Voltage Rise at PVDD .....1V/ $\mu\text{s}$

Stresses beyond those listed under "Absolute Maximum Ratings" may cause permanent damage to the device. These are stress ratings only, and functional operation of the device at these or any other conditions beyond those indicated in the operational sections of the specifications is not implied. Exposure to absolute maximum rating conditions for extended periods may affect device reliability.

## ELECTRICAL CHARACTERISTICS

( $V_{\text{PVDD}} = V_{\overline{\text{SHDN}}} = 5\text{V}$ ,  $V_{\text{PGND}} = 0\text{V}$ ,  $R_L = \infty$ , unless otherwise specified.  $R_L$  connected between OUT+ and OUT-, AC measurement bandwidth 20Hz to 22kHz,  $T_A = T_{\text{MIN}}$  to  $T_{\text{MAX}}$ , unless otherwise noted. Typical values are at  $T_A = +25^\circ\text{C}$ .) (Notes 1, 2)

PARAMETER	SYMBOL	CONDITIONS	MIN	TYP	MAX	UNITS	
<b>SPEAKER AMPLIFIER</b>							
Voltage Range	PVDD	Inferred from PSRR test	2.6		5.5	V	
Quiescent Supply Current	$I_{\text{DD}}$	$V_{\text{PVDD}} = 5.0\text{V}$		1.6	2.5	mA	
		$V_{\text{PVDD}} = 3.6\text{V}$		1.2			
Shutdown Supply Current	$I_{\text{SHDN}}$	$V_{\overline{\text{SHDN}}} = 0\text{V}$ , $T_A = +25^\circ\text{C}$		0.5	10	$\mu\text{A}$	
Turn-On Time	$t_{\text{ON}}$			1.9	4	ms	
Bias Voltage	$V_{\text{BIAS}}$			1.31		V	
Maximum AC Input Voltage	$V_{\text{IN}}$	Single ended		1		$V_{\text{RMS}}$	
		Differential		2			
Input Resistance in Shutdown	$R_{\text{INSD}}$	Between inputs		85.6		k $\Omega$	
		From inputs to PGND		43			
Input Resistance	$R_{\text{IN}}$		12	20		k $\Omega$	
Voltage Gain	$A_V$			12		dB	
Common-Mode Rejection Ratio	CMRR	$f_{\text{IN}} = 1\text{kHz}$ , input referred		48		dB	
Power-Supply Rejection Ratio	PSRR	$V_{\text{PVDD}} = 2.6\text{V}$ to $5.5\text{V}$ , $T_A = +25^\circ\text{C}$		54	64.3	dB	
		$PV_{\text{DDRIPPLE}} = 200\text{mV}_{\text{P-P}}$ (Note 3)	$f_{\text{RIPPLE}} = 217\text{Hz}$		72		
			$f_{\text{RIPPLE}} = 20\text{kHz}$		64		
Output Power	$P_{\text{OUT}}$	THD+N = 10%, $f_{\text{IN}} = 1\text{kHz}$	$R_L = 8\Omega$		1.5	W	
			$R_L = 4\Omega$		2.25		
Total Harmonic Distortion Plus Noise	THD+N	$f_{\text{IN}} = 1\text{kHz}$	$R_L = 8\Omega$ , $P_{\text{OUT}} = 0.5\text{W}$		0.04	%	
			$R_L = 4\Omega$ , $P_{\text{OUT}} = 1\text{W}$		0.04		
Output Offset Voltage	$V_{\text{OS}}$	$T_A = +25^\circ\text{C}$		$\pm 3$	$\pm 30$	mV	
Click-and-Pop Level	$K_{\text{CP}}$	Peak voltage, A-weighted, 32 samples/sec (Notes 3, 4)	Into shutdown		-56	dBV	
			Out of shutdown		-56		

# Mono 2W Class D Amplifier

MAX9830

## ELECTRICAL CHARACTERISTICS (continued)

( $V_{PVDD} = V_{SHDN} = 5V$ ,  $V_{PGND} = 0V$ ,  $R_L = \infty$ , unless otherwise specified.  $R_L$  connected between OUT+ and OUT-, AC measurement bandwidth 20Hz to 22kHz,  $T_A = T_{MIN}$  to  $T_{MAX}$ , unless otherwise noted. Typical values are at  $T_A = +25^\circ C$ .) (Notes 1, 2)

PARAMETER	SYMBOL	CONDITIONS	MIN	TYP	MAX	UNITS
Oscillator Frequency	$f_{OSC}$			600		kHz
Spread-Spectrum Bandwidth				$\pm 10$		kHz
Noise	$V_N$	A-weighted (Note 3)		39		$\mu V_{RMS}$
Signal-to-Noise Ratio	SNR	$P_{OUT} = P_{OUT}$ at 1% THD+N, A-weighted $R_L = 8\Omega$		98		dB
Output Current Limit	$I_{LIM}$	$T_A = +25^\circ C$		3		A
Thermal Shutdown Level				+180		$^\circ C$
Thermal Shutdown Hysteresis				30		$^\circ C$
Efficiency	$\eta$	$R_L = 8\Omega$ , $P_{OUT} = 1.5W$		85		%
<b>DIGITAL INPUT (SHDN)</b>						
Input Voltage High	$V_{IH}$		1.4			V
Input Voltage Low	$V_{IL}$				0.4	V
Input Leakage Current		$T_A = +25^\circ C$			$\pm 10$	$\mu A$

**Note 1:** All devices are 100% production tested at  $T_A = +25^\circ C$ . All temperature limits are guaranteed by design.

**Note 2:** Testing performed with a resistive load in series with an inductor to simulate an actual speaker load. For  $R_L = 4\Omega$ ,  $L = 33\mu H$ .  
For  $R_L = 8\Omega$ ,  $L = 68\mu H$ .

**Note 3:** Amplifier inputs AC-coupled to PGND with  $C_{IN} = 0.47\mu F$ .

**Note 4:** Specified at room temperature with an  $8\Omega$  resistive load in series with a  $68\mu H$  inductive load connected across BTL outputs.  
Mode transitions are controlled by SHDN.

# Mono 2W Class D Amplifier

## Typical Operating Characteristics

( $V_{PVDD} = V_{SHDN} = 5.0V$ ,  $V_{PGND} = 0V$ ,  $R_L = \infty$ , unless otherwise specified.  $R_L$  connected between OUT+ and OUT-, AC measurement bandwidth 20Hz to 22kHz,  $T_A = +25^\circ C$ , unless otherwise noted.)

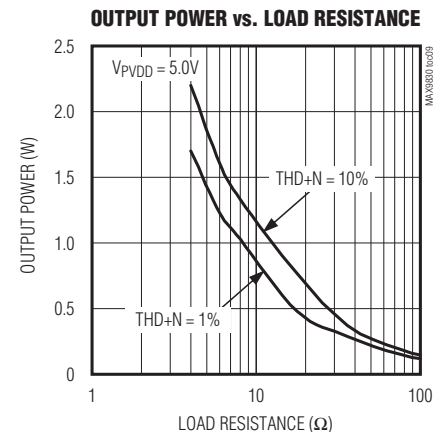
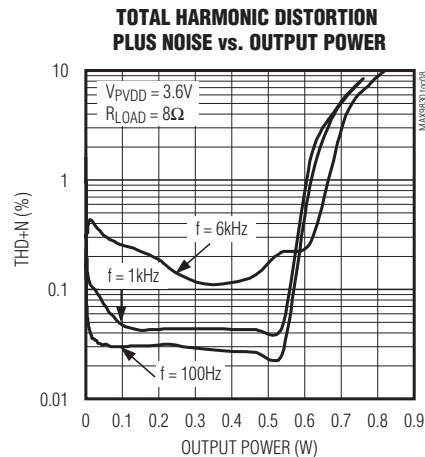
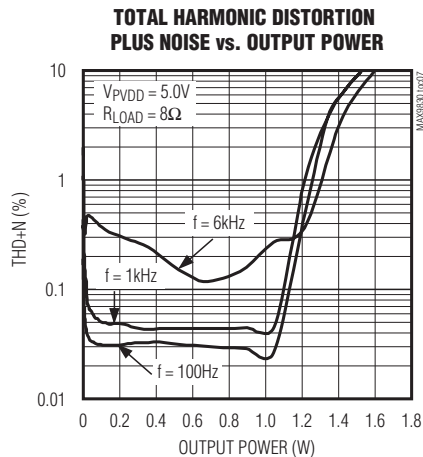
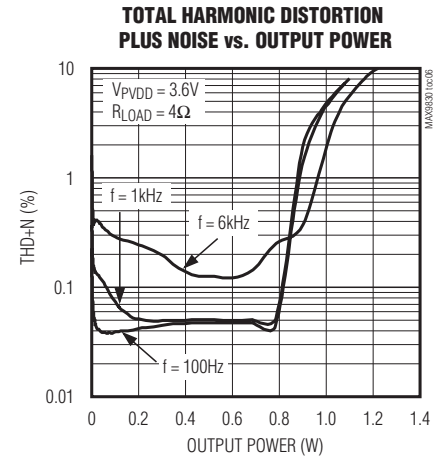
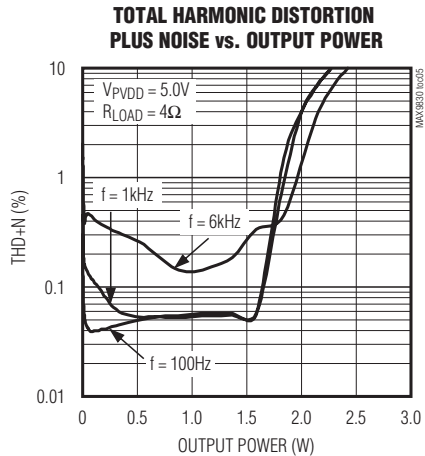
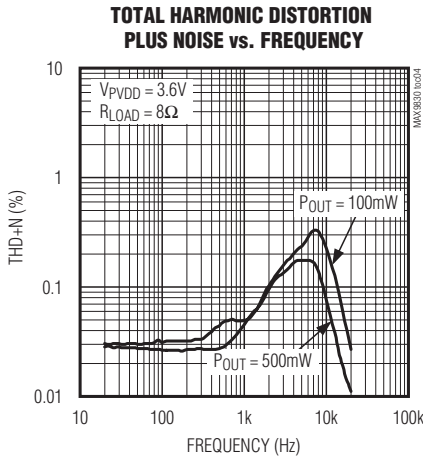
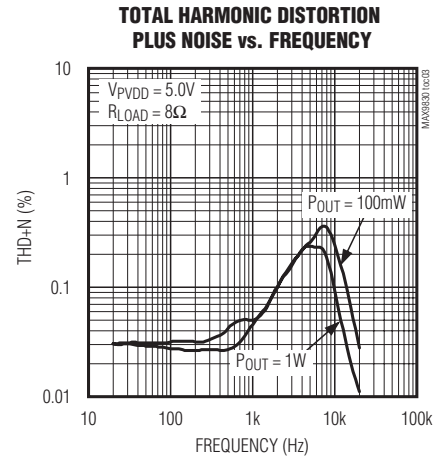
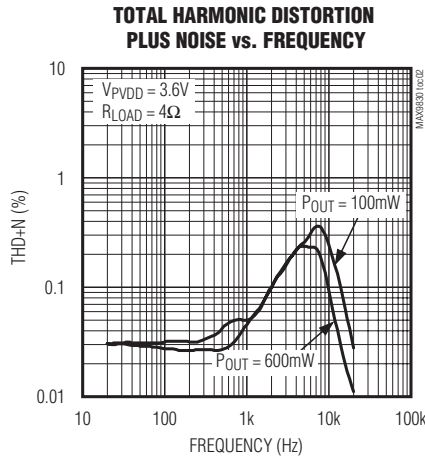
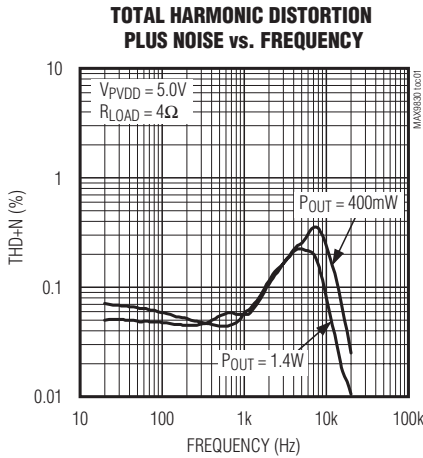

# Mono 2W Class D Amplifier

MAX9830

## Typical Operating Characteristics (continued)

( $V_{PVDD} = V_{SHDN} = 5.0V$ ,  $V_{PGND} = 0V$ ,  $R_L = \infty$ , unless otherwise specified.  $R_L$  connected between OUT+ and OUT-, AC measurement bandwidth 20Hz to 22kHz,  $T_A = +25^\circ C$ , unless otherwise noted.)

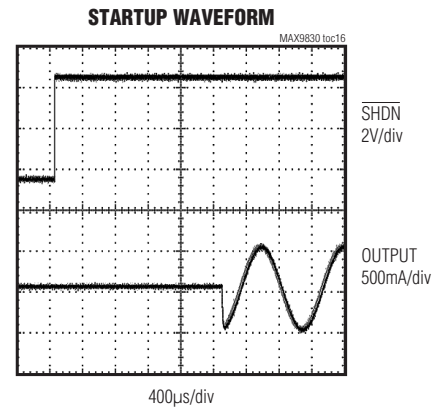
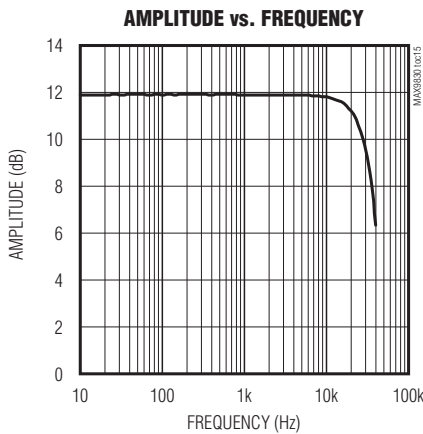
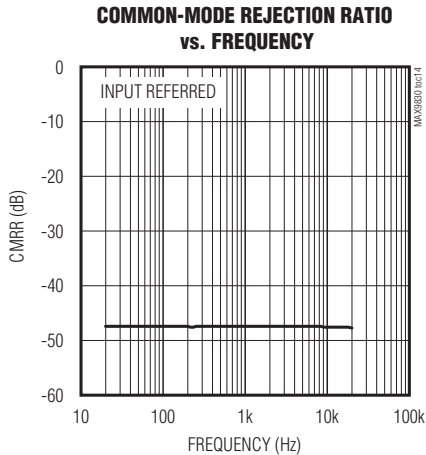
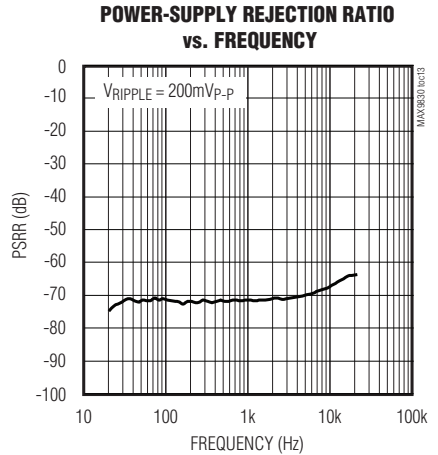
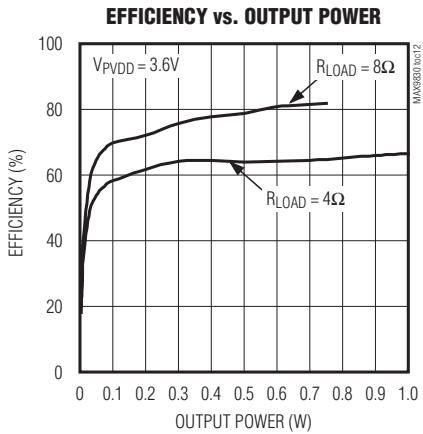
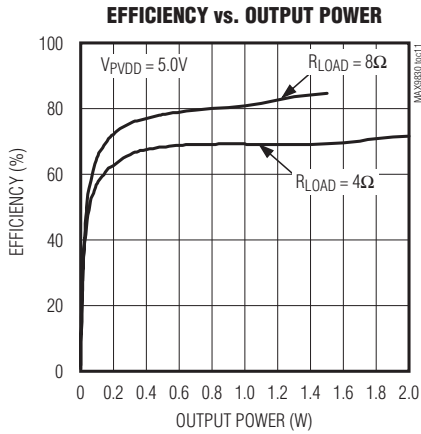
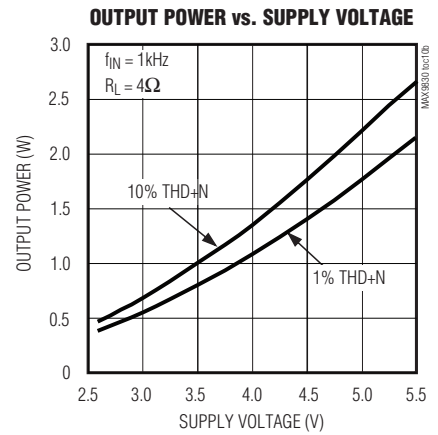
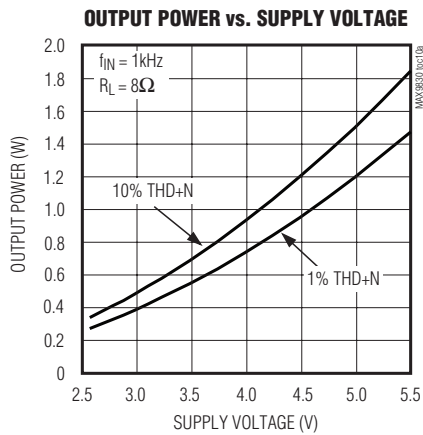
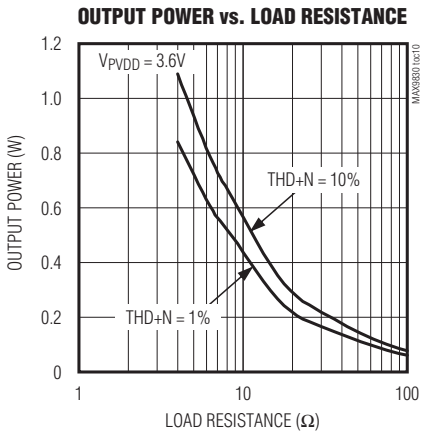

# Mono 2W Class D Amplifier

## Typical Operating Characteristics (continued)

( $V_{PVDD} = V_{SHDN} = 5.0V$ ,  $V_{PGND} = 0V$ ,  $R_L = \infty$ , unless otherwise specified.  $R_L$  connected between OUT+ and OUT-, AC measurement bandwidth 20Hz to 22kHz,  $T_A = +25^\circ C$ , unless otherwise noted.)

**SHUTDOWN WAVEFORM**

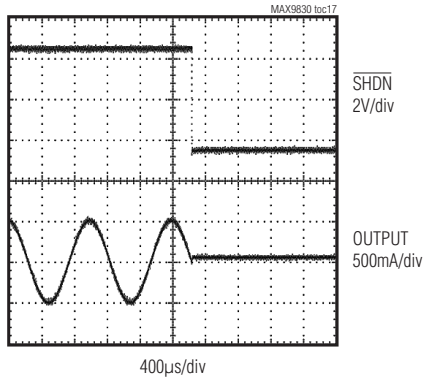

**WIDEBAND OUTPUT SPECTRUM**

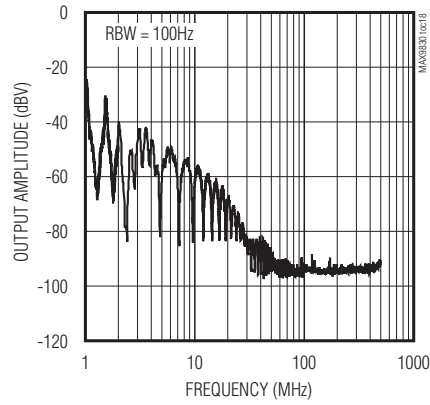

**OUTPUT FREQUENCY SPECTRUM**

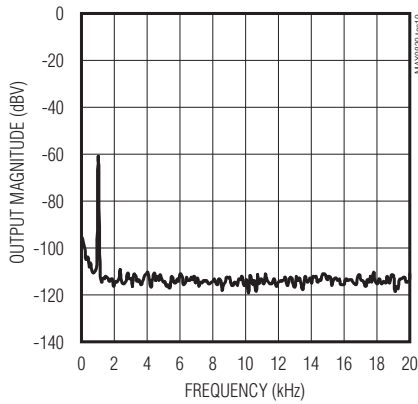

**SUPPLY CURRENT vs. SUPPLY VOLTAGE**

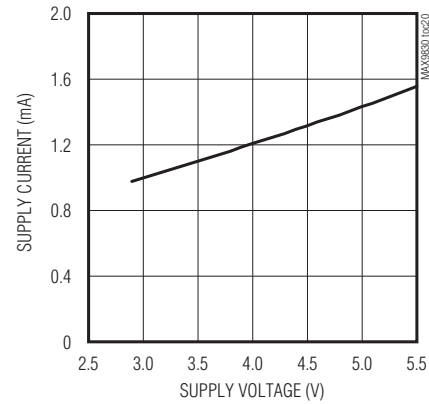

**SHUTDOWN CURRENT vs. SUPPLY VOLTAGE**

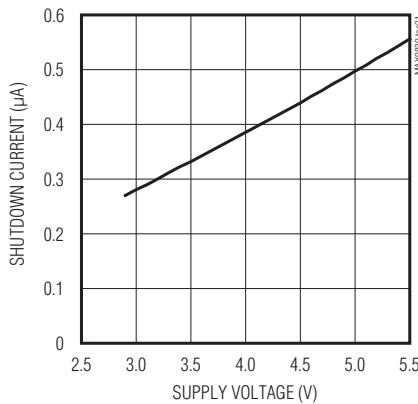

**RF IMMUNITY vs. FREQUENCY**

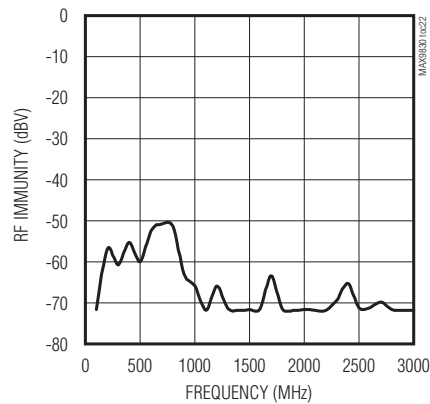

# Mono 2W Class D Amplifier

MAX9830

## Pin Description

PIN	NAME	FUNCTION
1	IN+	Noninverting Audio Input
2	IN-	Inverting Audio Input
3	SHDN	Active-Low Shutdown Input. Drive SHDN low to place the device in shutdown mode.
4	N.C.	No Connection. Leave unconnected.
5	PGND	Ground
6	OUT-	Negative Speaker Output
7	OUT+	Positive Speaker Output
8	PVDD	Power Supply. Bypass PVDD to PGND with a 0.1 $\mu$ F capacitor.
—	EP	Exposed Pad. Connect exposed pad to a solid ground plane.

## Detailed Description

The MAX9830 features industry-leading quiescent current, low-power shutdown mode, comprehensive click-and-pop suppression, and excellent RF immunity.

The MAX9830 offers Class AB audio performance with Class D efficiency in a minimal board-space solution. The Class D amplifier features spread-spectrum modulation combined with edge rate and overshoot control circuitry that offers significant improvements to switch-mode amplifier radiated emissions.

The MAX9830 includes thermal overload and short-circuit protection.

### Class D Speaker Amplifier

The MAX9830 filterless Class D amplifier offers much higher efficiency than Class AB amplifiers. The high efficiency of a Class D amplifier is due to the switching operation of the output stage transistors. Any power loss associated with the Class D output stage is mostly due to the  $I^2R$  loss of the MOSFET on-resistance and quiescent current overhead.

### Ultra-Low EMI Filterless Output Stage

Traditional Class D amplifiers require the use of external LC filters, or shielding, to meet EN55022B electromagnetic-interference (EMI) regulation standards. Maxim's active emissions limiting edge-rate control circuitry and spread-spectrum modulation reduces EMI emissions, while maintaining up to 85% efficiency.

Maxim's spread-spectrum modulation mode flattens wideband spectral components, while proprietary techniques ensure that the cycle-to-cycle variation of the switching period does not degrade audio reproduction or efficiency. The MAX9830's spread-spectrum modulator randomly varies the switching frequency by  $\pm 10$ kHz around the center frequency

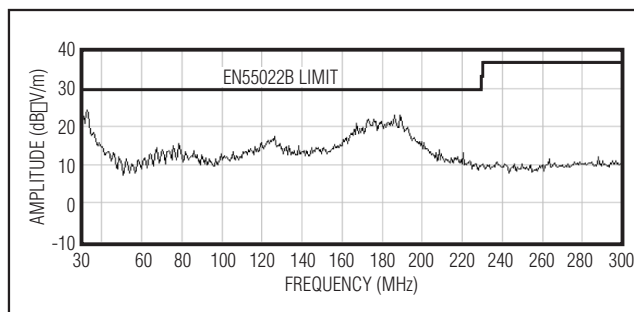

Figure 1. EMI with 24in of Speaker Cable

(600kHz). Above 10MHz, the wideband spectrum looks like noise for EMI purposes (Figure 1).

### Speaker Current Limit

If the output current of the speaker amplifier exceeds the current limit (1.8A typ), the MAX9830 disables the outputs for approximately 400 $\mu$ s. At the end of 400 $\mu$ s, the outputs are re-enabled. If the fault condition still exists, the MAX9830 continues to disable and re-enable the outputs until the fault condition is removed.

### Shutdown

The MAX9830 features a low-power shutdown mode, drawing 0.5 $\mu$ A of supply current. Drive SHDN low to put the MAX9830 into shutdown.

### Click-and-Pop Suppression

The MAX9830 speaker amplifier features Maxim's comprehensive click-and-pop suppression. During startup, the click-and-pop suppression circuitry reduces any audible transient sources internal to the device. When entering shutdown, the differential speaker outputs ramp down to PGND quickly and simultaneously.

# Mono 2W Class D Amplifier

## Applications Information

### Filterless Class D Operation

Traditional Class D amplifiers require an output filter. The filter adds cost, size, and decreases efficiency and THD+N performance. The MAX9830's filterless modulation scheme does not require an output filter.

Because the switching frequency of the MAX9830 is well beyond the bandwidth of most speakers, voice coil movement at the switching frequency is very small. Use a speaker with a series inductance > 10μH. Typical 8Ω speakers exhibit series inductances in the 20μH to 100μH range.

### Component Selection

#### Optional Ferrite Bead Filter

Although not normally needed, in applications where speaker leads exceed 24in at  $V_{PVDD} = 3V$ , use a filter constructed from an inexpensive ferrite bead and a small-value capacitor to ground (Figure 2) to provide additional EMI suppression. Use a ferrite bead with low DC resistance, high frequency ( $\geq 1MHz$ ) impedance of 100Ω to 600Ω, and rated for at least 1A. The capacitor value varies based on the ferrite bead chosen and the actual speaker lead length. Select the capacitor value based on EMI performance.

#### Speaker Amplifier Power Supply Input (PVDD)

PVDD powers the speaker amplifier. PVDD ranges from 2.6V to 5.5V. Bypass PVDD with a 0.1μF capacitor to PGND. Apply additional bulk capacitance at the device if long input traces between PVDD and the power source are used. Ensure a rate of voltage rise at PVDD is limited to 1V/μs.

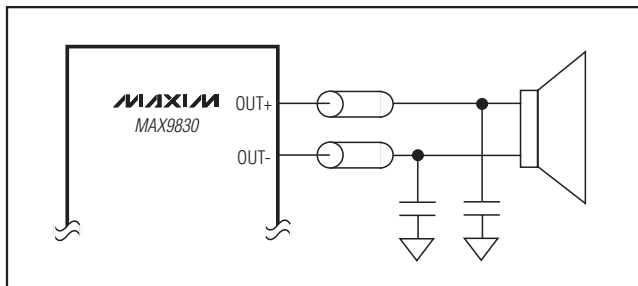

Figure 2. Optional Ferrite Bead Filter

### Input Filtering

The input-coupling capacitor ( $C_{IN}$ ), in conjunction with the amplifier's internal input resistance ( $R_{IN}$ ), forms a highpass filter that removes the DC bias from the incoming signal. These capacitors allow the amplifier to bias the signal to an optimum DC level. Select 0.47μF capacitors for optimum click-and-pop performance and 17Hz  $f_{-3dB}$ .

If a different  $f_{-3dB}$  is required,  $C_{IN}$ , assuming zero-source-impedance, is:

$$C_{IN} = \frac{8}{f_{-3dB}} [\mu F]$$

Use capacitors with adequately low voltage-coefficient for best low-frequency THD performance.

### Layout and Grounding

Proper layout and grounding are essential for optimum performance. Good grounding improves audio performance and prevents switching noise from coupling into the audio signal.

Use wide, low-resistance output traces. As load impedance decreases, the current drawn from the device outputs increase. At higher current, the resistance of the output traces decrease the power delivered to the load. For example, if 2W is delivered from the speaker output to a 4Ω load through a 100mΩ trace, 49mW is consumed in the trace. If power is delivered through a 10mΩ trace, only 5mW is consumed in the trace. Wide output, supply and ground traces also improve the power dissipation of the device.

The MAX9830 is inherently designed for excellent RF immunity. For best performance, add ground fills around all signal traces on top and bottom PCB planes.

The MAX9830 TDFN package features an exposed thermal pad on its underside. This pad lowers the package's thermal resistance by providing a heat conduction path from the die to the PCB. Connect the exposed thermal pad to the ground plane by using a large pad and multiple vias.

## Chip Information

PROCESS: CMOS



# Mono 2W Class D Amplifier

## Functional Diagram

MAX9830

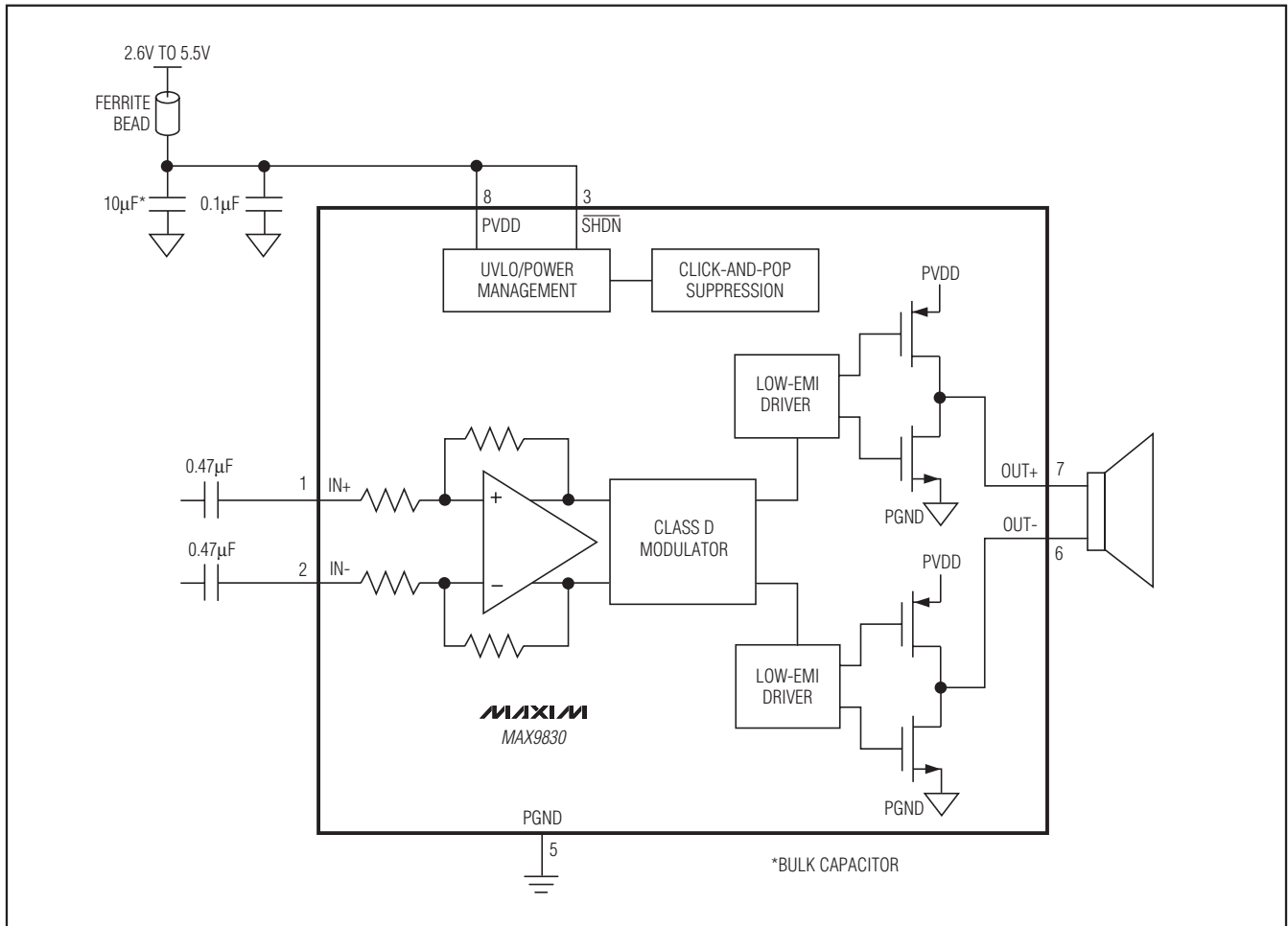

# Mono 2W Class D Amplifier

## Package Information

For the latest package outline information and land patterns, go to [www.maxim-ic.com/packages](http://www.maxim-ic.com/packages). Note that a "+", "#", or "-" in the package code indicates RoHS status only. Package drawings may show a different suffix character, but the drawing pertains to the package regardless of RoHS status.

PACKAGE TYPE	PACKAGE CODE	DOCUMENT NO.
8 TDFN-EP	T822+2	<a href="#">21-0168</a>

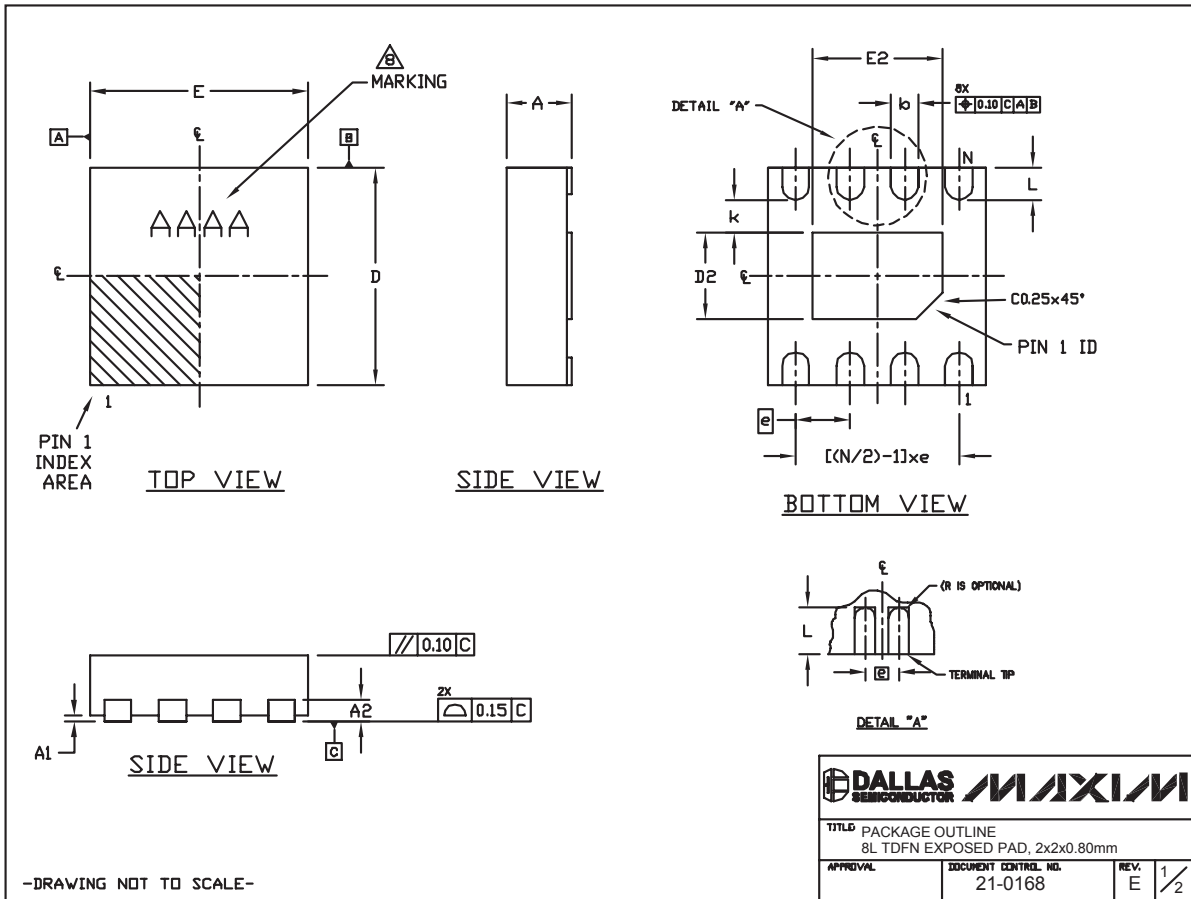

# Mono 2W Class D Amplifier

MAX9830

## Package Information (continued)

For the latest package outline information and land patterns, go to [www.maxim-ic.com/packages](http://www.maxim-ic.com/packages). Note that a "+", "#", or "-" in the package code indicates RoHS status only. Package drawings may show a different suffix character, but the drawing pertains to the package regardless of RoHS status.

COMMON DIMENSIONS		
SYMBOL	MIN.	MAX.
A	0.70	0.80
D	1.90	2.10
E	1.90	2.10
A1	0.00	0.05
L	0.20	0.40
k	0.25 MIN.	
A2	0.20 REF.	

PACKAGE VARIATIONS							
PKG. CODE	N	D2	E2	e	b	r	[(N/2)-1] x e
T822-1	8	0.70±0.10	1.30±0.10	0.50 TYP.	0.25±0.05	0.125	1.50 REF
T822-2	8	0.80±0.10	1.20±0.10	0.50 TYP.	0.25±0.05	0.125	1.50 REF

### NOTES:

1. ALL DIMENSIONS ARE IN mm. ANGLES IN DEGREES.
2. COPLANARITY APPLIES TO THE EXPOSED PAD AS WELL AS THE TERMINALS. COPLANARITY SHALL NOT EXCEED 0.08mm.
3. WARPAGE SHALL NOT EXCEED 0.08mm.
4. PACKAGE LENGTH/PACKAGE WIDTH ARE CONSIDERED AS SPECIAL CHARACTERISTIC(S).
5. COMPLY TO JEDEC MQ229 EXCEPT D2 AND E2 DIMENSIONS.
6. 'N' IS THE TOTAL NUMBER OF LEADS.
7. NUMBER OF LEADS SHOWN ARE FOR REFERENCE ONLY.
8. MARKING IS FOR PACKAGE ORIENTATION REFERENCE ONLY.
9. ALL DIMENSIONS APPLY TO BOTH LEADED AND Pbf-FREE PARTS.

-DRAWING NOT TO SCALE-

		
<b>TITLE:</b> PACKAGE OUTLINE 8L TDFN EXPOSED PAD, 2x2x0.80mm		
<b>APPROVAL:</b>	<b>DOCUMENT CONTROL NO.</b> 21-0168	<b>REV.</b> E 2/2

# Mono 2W Class D Amplifier

## Revision History

REVISION NUMBER	REVISION DATE	DESCRIPTION	PAGES CHANGED
0	8/09	Initial release	—
1	4/10	Removed PSRR spec from the <i>Features</i> section, updated EC table specs, and added new TOCs	1, 2, 5

Maxim cannot assume responsibility for use of any circuitry other than circuitry entirely embodied in a Maxim product. No circuit patent licenses are implied. Maxim reserves the right to change the circuitry and specifications without notice at any time.

12 \_\_\_\_\_ **Maxim Integrated Products, 120 San Gabriel Drive, Sunnyvale, CA 94086 408-737-7600**

© 2010 Maxim Integrated Products

Maxim is a registered trademark of Maxim Integrated Products, Inc.